

+SKIN COLLECTION

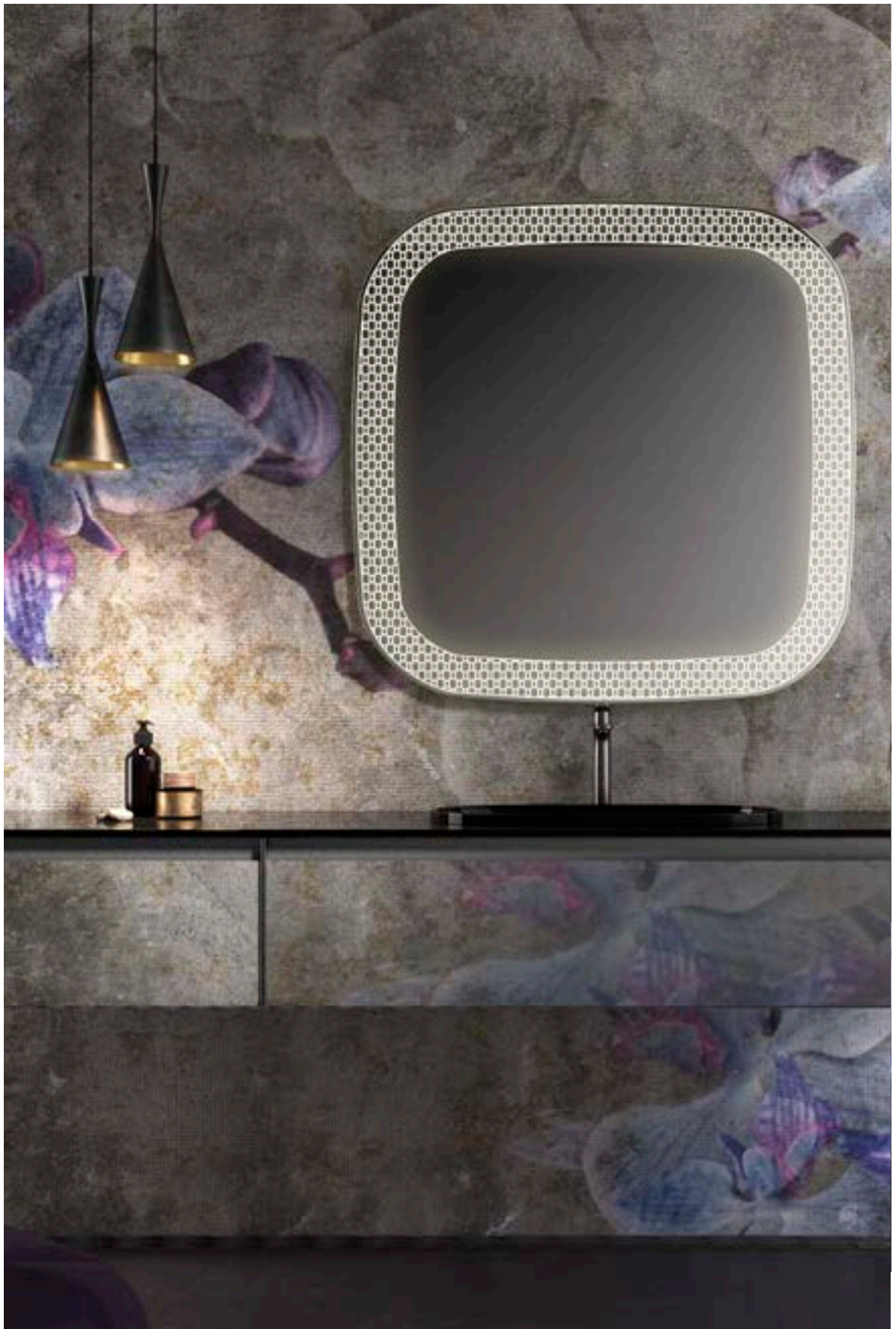

+SKIN Collection



ORDINA FACILE

EASY ORDER

ORDENA EL PEDIDO

YOU SHOULD INDICATE IN YOUR PO:

- item code
- finishes of the structure
- covering colour
- top/basin top colour
- position and type of fusion (for basin tops)
- position and model of basin (for tops)
- position and number of tap holes
- furniture sequence (for compositions)
- options (if requested)

INDICARE NELL'ORDINE:

- codice articolo
- finitura struttura
- colore rivestimento
- colore top/basintop
- posizione e tipo fusione (per basintop)
- posizione e modello lavabo (per top)
- posizione e numero fori rubinetto
- sequenza dei mobili (per composizioni)
- optional (se richiesti)

INDICAR EN EL PEDIDO:

- código artículo
- acabado estructura
- color revestimiento
- color top/basintop
- posición y tipo de la fusión (para el basintop)
- posición y modelo de lavabo (para el top)
- posición y número de agujeros para grifería
- secuencia de los muebles (para la composición)
- Opciones (si se solicitan)

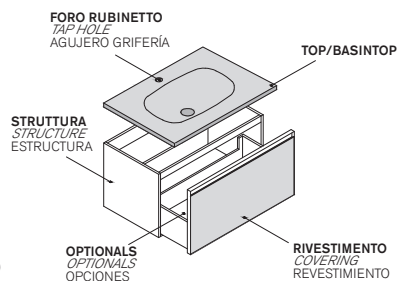

Note:

14 Componente affiancabile con altri di uguale profondità.

The component can be positioned alongside other components with the same depth.

Componentes combinables con otros de igual profundidad.

17 BASIN TOP sono realizzati con la fusione INCISA di serie. Sui portalavabo da 60cm e 135cm doppio lavabo le fusioni, fermo restando le caratteristiche tecniche, saranno ridimensionate in funzione dello spazio del mobile.

The BASIN TOPS are manufactured with the INCISA fusion as standard. On the 60 cm basin units and 135 cm double basin units, fusions will follow the same technical specifications as the other fusions but they will be resized according to the dimensions of the units.

Los BASIN TOP son fabricados con la fusión INCISA de serie. Para los portalavabos de 60 cm y 135 cm con doble lavabo las fusiones, teniendo en cuenta las características técnicas, serán redimensionados en función del espacio del mueble.

CARATTERISTICHE TECNICHE DEL PRODOTTO

TECHNICAL CHARACTERISTICS

CARACTERÍSTICAS TÉCNICAS DEL PRODUCTO

STRUTTURA - STRUCTURE - ESTRUCTURA

Struttura in nobilitato melaminico idro grigio scuro RAL7010 con Fianchi in MDF verniciato "PELTRO o BRONZO". Frontale cassetto con cornice in alluminio verniciato "PELTRO o BRONZO" con battuta abbinata.

Structure in dark grey hydro repellent lacquered melamine laminate, RAL 7010. Sides in enameled MDF "PELTRO or BRONZO" finishes. Front drawer with frame in aluminium varnished in "PELTRO or BRONZO" finishes and matching strip.

Estructura de ennoblecido melamínico idro gris oscuro RAL7010 con laterales de MDF barnizado "PELTRO O BRONZO". Frontal de cajón con cornisa de aluminio barnizado "PELTRO O BRONZO" con frontal combinado.



PE peltro



BR bronzo

GUIDE - DRAWER RUNNERS - GUIAS

BLUM ad estrazione totale, movimento LEGRABOX e chiusura sistema BLUMOTION, regolabili in verticale ed orizzontale. Portata cassette e cestoni Kg. 40.

BLUM drawer runners with total extraction, LEGRABOX movement and BLUMOTION closure system, adjustable both vertically and horizontally. Drawers can hold up to 40 Kg.

BLUM de extracción total, movimiento LEGRABOX y cierre sistema BLUMOTION, regulable en vertical y horizontal. Peso soportado por cajones o cajoneras 40 Kg.

ATTACCAGLIE - WALL BRACKETS - SOPORTES

Attaccaglie regolabili CAMAR per fissaggio a parete portalavabo, basi, pensili e colonne.

CAMAR adjustable wall supports for basin units, units, cabinets and columns.

Soporte regulable CAMAR para fijación a pared del portalavabo, bases, armarios y columnas.

RIVESTIMENTO ESTERNO - EXTERNAL COVERING - REVESTIMIENTO EXTERNO

CRISTALLO SMALTATO. I cristalli colorati Artelinea sono garantiti secondo i termini di legge.

ENAMELED GLASS. Artelinea coloured glass is produced in accordance with all relevant manufacturing standards and regulations.

CRISTAL ESMALTADO. Los cristales coloreados Artelinea tienen garantía según el término de la ley.

Cristallo cannettato verniciato Flutes nero, bronzo e bianco.

LAMINAM® 3mm e 5mm

SPECCHIO FUME' GRIGIO/ FUME' BRONZO/ STAMPATO GRIGIO/ STAMPATO BRONZO

GLASS Collection: decoro CHERRY, CALYPSO e GARDEN.

Enameled ribbed glass Flutes nero, bronzo and bianco.

LAMINAM® 3mm and 5mm

SPECCHIO FUME' GRIGIO/ FUME' BRONZO/ STAMPATO GRIGIO/ STAMPATO BRONZO

GLASS Collection: CHERRY, CALYPSO and GARDEN decorations.

Cristal acanalado barnizado Flutes negro, bronce o blanco.

LAMINAM 3mm y 5mm

ESPEJO FUME' GRIS / FUME' BRONCE / ESTAMPADO GRIS / ESTAMPADO BRONCE.

GLASS Collection: decoración CHERRY, CALYPSO o GARDEN.

NEW
moho

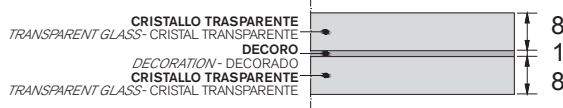
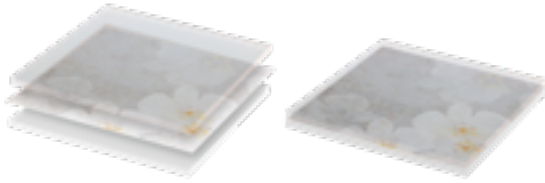

NEW
glass
DECOR



TOP MOHO

Top formato dall'accoppiamento di stratifica tra 2 cristalli trasparenti extrachiari sp.8 mm e decoro interposto per uno spessore totale di circa 17 mm. Top disponibile a partire da 90 cm di larghezza con i 3 decori Cherry, Calypso e Garden.

Top formed by the stratified matching of 2 layers of extra-clear transparent glass, 8mm each, and 1 central layer of decoration for a total thickness of about 17 mm. Top available from a minimum length of 90 cm with the 3 decorations: Cherry, Calypso and Garden.

Top formado por el acoplamiento laminado entre 2 cristales transparentes extraclaros grosor 8 mm y decorado interpuesto con un grosor total de aproximadamente 17 mm. Top disponible a partir de 90 cm de longitud con los 3 decorados Cherry, Calypso y Garden.

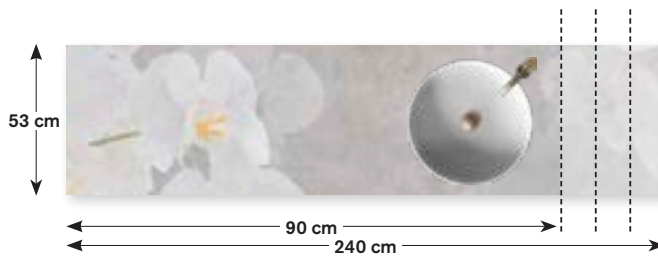

CE Cherry



CL Calypso



GA Garden

ALZATINA GLASS - BACKSPLASH GLASS- COPETE GLASS

Alzatina formata dall'accoppiamento di stratifica tra 2 cristalli trasparenti extrachiari sp.8 mm e decoro interposto per uno spessore totale di circa 17 mm. Alzatina disponibile a partire da 90 cm di larghezza con i 3 decori Cherry, Calypso e Garden.

Backsplash formed by the stratified matching of 2 layers of extra-clear transparent glass, 8mm each, and 1 central layer of decoration for a total thickness of about 17 mm. Backsplash available from a minimum length of 90 cm with the 3 decorations: Cherry, Calypso and Garden.

Copete formado por el acoplamiento laminado entre 2 cristales transparentes extraclaros grosor 8 mm y decorado interpuesto con un grosor total de aproximadamente 17 mm. Copete disponible a partir de 90 cm de longitud con los 3 decorados Cherry, Calypso y Garden.



CE Cherry



CL Calypso



GA Garden

+SKIN Collection

Mobile con rivestimento Laminam® Filo Ghisa.

Vanity with covering in Laminam® Filo Ghisa.

Mueble con revestimiento Laminam Filo Ghisa.



Particolare cassetto con rivestimento Calypso.

Detail of a drawer with Calypso covering.

Detalles del cajón con revestimiento Calypso.



Mobile con rivestimento Laminam® Filo Argento.

Vanity with covering in Laminam® Filo Argento.

Mueble con revestimiento Laminam Filo Argento.



Particolari top MOHO Collection.

MOHO Collection top details.

Detalles del top MOHO Collection.



+SKIN Collection

SCHEDE TECNICHE PER INSTALLAZIONE

TECHNICAL INSTALLATION ADVICE

ESQUEMA TECNICO PARA INSTALACION

<p>PORTALAVABO H.30 cm <i>BASIN UNITS H.30 CM</i> PORTALAVABO H.30 CM</p>		<p>PORTALAVABO H.50 cm <i>BASIN UNITS H.50 CM</i> PORTALAVABO H.50 CM</p>	
<p>BASINTOP/LAVABI SOTTOPIANO <i>UNDER LEVEL WASH-BASINS</i> BASINTOP/LAVABOS BAJOENCIMERA</p>		<p>BASINTOP/LAVABI SOTTOPIANO <i>BASIN TOP/UNDER LEVEL WASH-BASINS</i> BASINTOP/LAVABOS BAJOENCIMERA</p>	
<p>LAVABI IN APPOGGIO H = 10/15 cm <i>OVER LEVEL WASH-BASINS H = 10/15 cm</i> LAVABO DE APOYO H = 10/15 cm</p>		<p>LAVABI IN APPOGGIO H = 10/15 cm <i>OVER LEVEL WASH-BASINS H = 10/15 cm</i> LAVABO DE APOYO H = 10/15 cm</p>	
<p>LAVABI SEMINCASSO H = 6/9 cm <i>SEMI-RECESSED BASIN H = 6/9 cm</i> LAVABOS DE SEMIENCASTRE H = 6/9 cm</p>		<p>LAVABI SEMINCASSO H = 6/9 cm <i>SEMI-RECESSED BASIN H = 6/9 cm</i> LAVABOS DE SEMIENCASTRE H = 6/9 cm</p>	

Modularità

Modularity

Modularidad

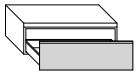

Basi
Bases
Bases

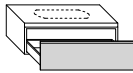

Portalavabo e Basi
Basin units and Bases
Portalavabos y Bases

Lavabi consentiti - Allowed basins - Lavabos permitidos



Lavabo appoggio - Over level basins - Lavabos de apoyo

Lavabo semincasso - Semi-recessed basins - Lavabos semiencastre

Lavabo sottopiano - Under level basins - Lavabos bajo encimera

Lavabo integrato - Integrated basins - Lavabo integrado

H 30 CM
P 53 CM

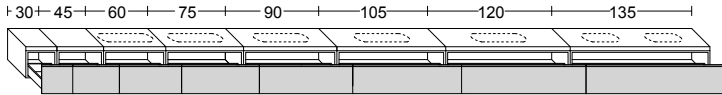

H 50 CM
P 53 CM

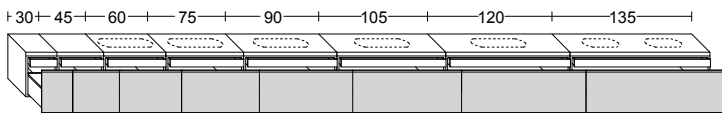
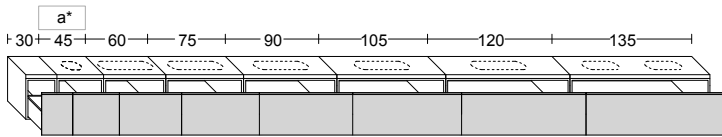

FUSIONE - FUSIONS - FUSIÓN

INCISA48

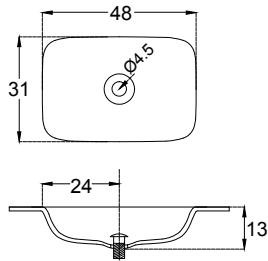

INCISA62

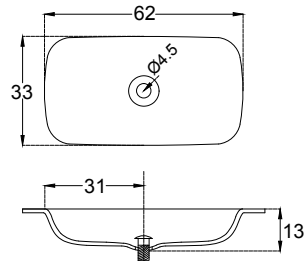

Alcuni esempi di composizioni.

Examples of compositions.

Algunos ejemplos de composiciones.



Porta lavabo e basi con 1 cassetto.

Basin units and base units with 1 drawer.

Porta lavabo y bases con 1 cajón.

Cristallo smaltato
Enameled crystal
 Cristal esmaltado
Flutes
Specchi

LAMINAM®
Cherry, Calypso,
Garden

Note: 14 (pag. 8)

Porta lavabo con cassetto asolato per passaggio sifone. Lavabo centrale.

Basin unit with central drainage hole. Central basin.

Porta lavabo 1 cajón con ojal para paso de sifón. Lavabo centrado.

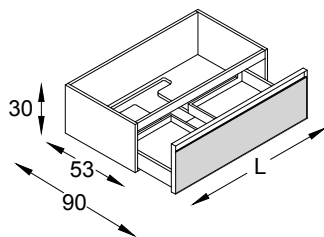

L cm	Art.		
60	SKA60		
75	SKA75		
90	SKA90		
105	SKA105		
120	SKA120		
135	SKA135		

Note: 14 (pag. 8)

Porta lavabo con cassetto asolato per passaggio sifone. Lavabo doppio.

Basin unit with double drainage holes. Double basins.

Porta lavabo 1 cajón con ojal para paso de sifón. Doble lavabo.

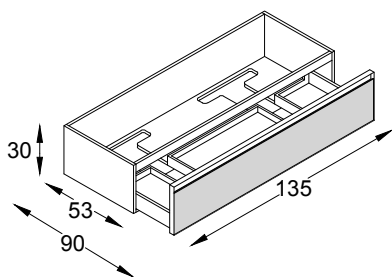

L cm	Art.		
135	SKA135D		

Note: 14 (pag. 8)

Base con 1 cassetto intero.

Base unit with 1 drawer.

Base con 1 cajón sin ojal.

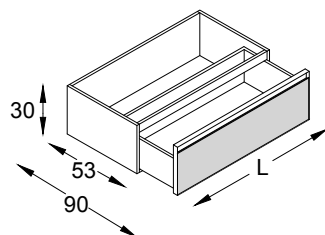

L cm	Art.		
30	SKY30		
45	SKY45		
60	SKY60		
75	SKY75		
90	SKY90		
105	SKY105		
120	SKY120		
135	SKY135		

Colori vedi pag. 4. - Colours see page 4. - Colores ver página 4.

Portavavabo e basi con cestone.

Basin units and base units with deep drawers.

Portavavabo y bases con cajonera.

	<p>Cristallo smaltato <i>Enameled crystal</i> Cristal esmaltado</p> <p>Flutes Specchi</p>	<p>LAMINAM® Cherry, Calypso, Garden</p>
--	---	--

Note: 14 (pag. 8)

Portavavabo con cestone, divisori in cristallo e cassetino interno asolato per passaggio sifone. Lavabo centrale.

Basin unit with deep drawer, glass dividers and inner drawer with drainage hole. Central basin.

Portavavabo con cajonera, divisorio de cristal, cajón interno con ojal para paso de sifón. Lavabo centrado.

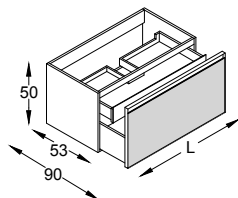

L cm	Art.		
60	SKE60		
75	SKE75		
90	SKE90		
105	SKE105		
120	SKE120		
135	SKE135		

Note: 14 (pag. 8)

Portavavabo con cestone, divisori in cristallo e cassetino interno asolato per passaggio sifoni. Lavabo doppio.

Basin unit with deep drawer, glass dividers and inner drawer with drainage holes. Double basins.

Portavavabo con cajonera, divisorio de cristal, cajón interno con ojal para paso de sifón. Doble lavabo.

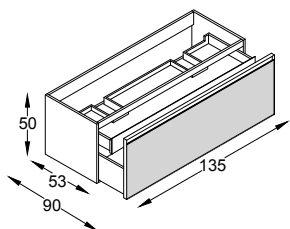

L cm	Art.		
135	SKE135D		

Note: 14 (pag. 8)

Portavavabo e base con cestone e divisori in cristallo. Lavabo centrale.

Basin unit and base unit with deep drawer and glass dividers. Central basin.

Portavavabo y base con cajonera y divisorio de cristal. Lavabo centrado.

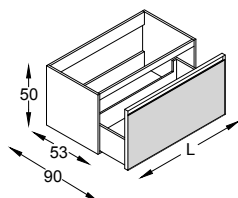

L cm	Art.		
30	SKF30		
45	SKF45		
60	SKF60		
75	SKF75		
90	SKF90		
105	SKF105		
120	SKF120		
135	SKF135		

Note: 14 (pag. 8)

Base con cestone, divisori in cristallo e cassetino interno.

Base unit with deep drawer, glass dividers and inner drawer.

Base con cajonera, divisorio de cristal y cajón interno.

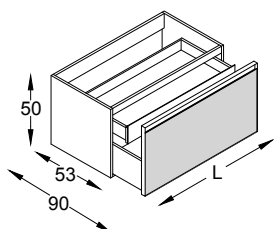

L cm	Art.		
30	SKL30		
45	SKL45		
60	SKL60		
75	SKL75		
90	SKL90		
105	SKL105		
120	SKL120		
135	SKL135		

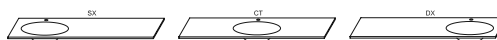

BASIN TOP CRISTALLO, OPALITE E CRISTALPLANT

Indicare posizione lavabo - Indicate position of basin - Indicar posición lavabo

Note: **17** (pag. 8)

Basin top in CRISTALLO smaltato, OPALITE BIANCO e CRISTALPLANT - FUSIONE SINGOLA.
Basin top in enameled CRISTALLO, OPALITE BIANCO and CRISTALPLANT - SINGLE FUSION.
 Basin top de CRISTAL esmaltado, OPALITE BLANCO o CRISTALPLANT - 1 LAVABO.

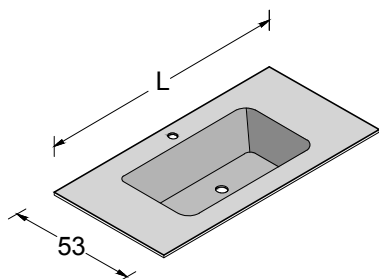

L cm	Art.	OPALITE		
		CRISTALLO	BIANCO	CRISTALPLANT
60	BTSK 60			
75	BTSK 75			
90	BTSK 90			
105	BTSK 105			
120	BTSK 120			
135	BTSK 135			
150	BTSK 150			
165	BTSK 165			
180	BTSK 180			
195	BTSK 195			
210	BTSK 210			
225	BTSK 225			
240	BTSK 240			

- 1) Foro rubinetteria monoforo centrale di serie. Su richiesta senza foro, 3 fori.**

Single central tap hole as standard. Upon request 3 tap holes or no tap hole.

Agujero grifería centrado de serie. Sobre pedido sin agujero, 3 agujeros.

- 2) Top per composizioni a misura prendere il prezzo della lunghezza superiore. (Es. composizione 200 cm prezzo top 210 cm).**

Use tops of a wider length for made-to-measure compositions (Ex. for a composition L. 200 cm consider the top L. 210 cm).

Encimera para composiciones a medida tomar el precio de la longitud superior (Ejemplo: composición 200 cm precio encimera 210 cm).

- 3) Colori satinati (con fusione lucida) sovrapprezzo 10% sul prezzo del cristallo. Opalite nero sovrapprezzo del 30% sul prezzo dell'Opalite bianco.**

Matt colours increase of 10% on the crystal price. Opalite nero increase of 30% on the Opalite bianco price.

Colores satinados (con fusión brillo) aumento 10% sobre el precio del cristal. Opalite negro aumento del 30% sobre el precio del Opalite Blanco.

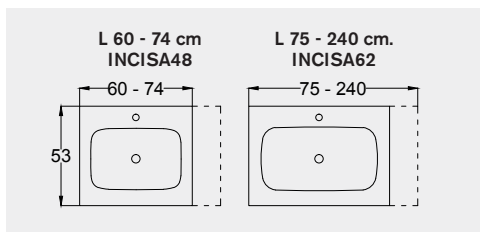

Fusione INCISA di serie
Standard fusion INCISA
 Fusion INCISA de serie



Molatura bordi - Edge grinding - Acabados del borde



Inclusa - Included - Incluida

Colori vedi pag. 4. - Colours see page 4. - Colores ver página 4.
 FUSIONI - vedi pag. 12. - Fusions see page 12. - FUSIONES - ver pág. 12.

BASIN TOP CRISTALLO, OPALITE E CRISTALPLANT

Note: **17** (pag. 8)

Basin top in CRISTALLO smaltato, OPALITE BIANCO e CRISTALPLANT - FUSIONE DOPPIA.

Basin top in enameled CRISTALLO, OPALITE BIANCO and CRISTALPLANT - DOUBLE FUSIONS.

Basin top de CRISTAL esmaltado, OPALITE BLANCO o CRISTALPLANT - 2 LAVABOS.

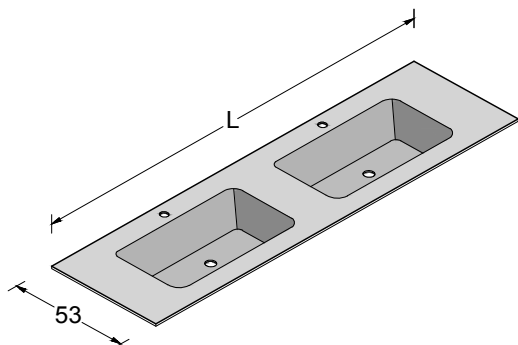

L cm	Art.	CRISTALLO	OPALITE BIANCO	CRISTALPLANT
135	BTSKD 135			
150	BTSKD 150			
165	BTSKD 165			
180	BTSKD 180			
195	BTSKD 195			
210	BTSKD 210			
225	BTSKD 225			
240	BTSKD 240			

- 1) Foro rubinetteria monoforo centrale di serie. Su richiesta senza foro, 3 fori.**

Single central tap hole as standard. Upon request 3 tap holes or no tap hole.

Agujero grifería centrado de serie. Sobre pedido sin agujero, 3 agujeros.

- 2) Top per composizioni a misura prendere il prezzo della lunghezza superiore. (Es. composizione 200 cm prezzo top 210 cm).**

Use tops of a wider length for made-to-measure compositions (Ex. for a composition L. 200 cm consider the top L. 210 cm).

Encimera para composiciones a medida tomar el precio de la longitud superior (Ejemplo: composición 200 cm precio encimera 210 cm).

- 3) Colori satinati (con fusione lucida) sovrapprezzo 10% sul prezzo del cristallo. Opalite nero sovrapprezzo del 30% sul prezzo dell'Opalite bianco.**

Matt colours increase of 10% on the crystal price. Opalite nero increase of 30% on the Opalite bianco price.

Colores satinados (con fusión brillo) aumento 10% sobre el precio del cristal. Opalite negro aumento del 30% sobre el precio del Opalite Blanco.

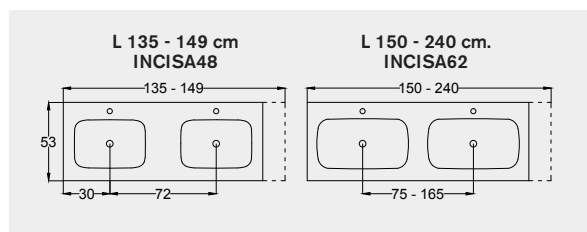

Fusione INCISA di serie

Standard fusion INCISA

Fusion INCISA de serie



Molatura bordi - Edge grinding - Acabados del borde



Inclusa - Included - Incluida

Colori vedi pag. 4. - Colours see page 4. - Colores ver página 4.

FUSIONI - vedi pag. 12. - Fusions see page 12. - FUSIONES - ver pág. 12.



TOP CRISTALLO E OPALITE

Indicare posizione lavabo - Indicate position of basin - Indicar posición lavabo

Top in CRISTALLO smaltato e OPALITE per lavabo in appoggio, sottopiano e semincasso - LAVABO SINGOLO.

Top in enameled CRISTALLO and OPALITE for sit on, under level and semi-recessed basins - SINGLE BASIN.

Top de CRISTAL esmaltado u OPALITE para lavabo de apoyo, bajoencimera o semiencastré - 1 LAVABO.

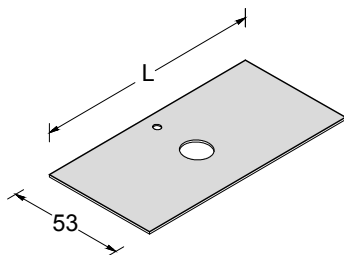

L cm	Art.	CRISTALLO	OPALITE BIANCO
45	KML 45		
60	KML 60		
75	KML 75		
90	KML 90		
105	KML 105		
120	KML 120		
135	KML 135		
150	KML 150		
165	KML 165		
180	KML 180		
195	KML 195		
210	KML 210		
225	KML 225		
240	KML 240		

Top in CRISTALLO smaltato e OPALITE per lavabo in appoggio, sottopiano e semincasso - LAVABO DOPPIO.

Top in enameled CRISTALLO and OPALITE for sit on, under level and semi-recessed basins - DOUBLE BASINS.

Top de CRISTAL esmaltado u OPALITE para lavabo de apoyo, bajoencimera o semiencastré - 2 LAVABOS.

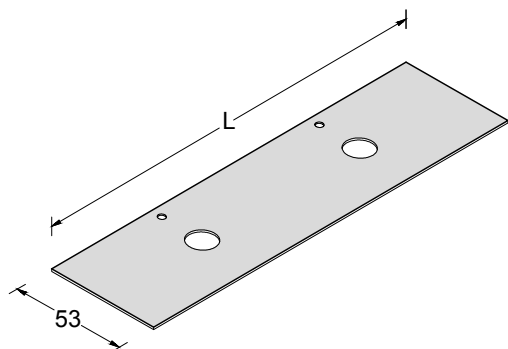

L cm	Art.	CRISTALLO	OPALITE BIANCO
120	KMLD 120		
135	KMLD 135		
150	KMLD 150		
165	KMLD 165		
180	KMLD 180		
195	KMLD 195		
210	KMLD 210		
225	KMLD 225		
240	KMLD 240		

- 1) **Foro rubinetteria monoforo centrale di serie. Su richiesta senza foro, 3 fori.**

Single central tap hole as standard. Upon request 3 tap holes or no tap hole.

Agujero grifería centrado de serie. Sobre pedido sin agujero, 3 agujeros.

- 3) **Colori satinati sovrapprezzo 10% sul prezzo del cristallo. Opalite nero sovrapprezzo del 35% sul prezzo dell'Opalite bianco.**

Matt colours increase of 10% on the crystal price. Opalite nero increase of 35% on the Opalite bianco price.

Colores satinados aumento 10% sobre el precio del cristal. Opalite negro aumento del 35% sobre el precio del Opalite Blanco.

- 2) **Top per composizioni a misura prendere il prezzo della lunghezza superiore (Es. composizione 200 cm prezzo top 210 cm).**

Use tops of a wider length for made-to-measure compositions (Ex. for a composition L. 200 cm consider the top L. 210 cm).

Encimera para composiciones a medida tomar el precio de la longitud superior (Ejemplo: composición 200 cm precio encimera 210 cm).

- 4) **Per l'utilizzo di altri lavabi no Artelinea indicare marca e modello con aumento di €. Richiedere fattibilità.**

For all the basins which are not produced by Artelinea please indicate brand and model and increase the price of the top by € Ask for feasibility.

Para lavabos de otros fabricantes indicar marca y modelo con aumento de €. Consultar factibilidad.



Molatura bordi - Edge grinding - Acabados del borde



Inclusa - Included - Incluida

Colori vedi pag. 4. - Colours see page 4. - Colores ver página 4.

TOP CRISTALLO E OPALITE

Top in CRISTALLO smaltato e OPALITE per basi e cassettiere senza lavabo.

Top in enameled CRISTALLO or OPALITE for base units.

Top de CRISTAL esmaltado u OPALITE para bases y cajoneras sin lavabo.

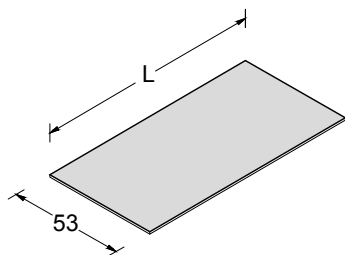

L cm	Art.	CRISTALLO	OPALITE BIANCO
30	KMLC 30		
45	KMLC 45		
60	KMLC 60		
75	KMLC 75		
90	KMLC 90		
105	KMLC 105		
120	KMLC 120		
135	KMLC 135		
150	KMLC 150		
165	KMLC 165		
180	KMLC 180		
195	KMLC 195		
210	KMLC 210		
225	KMLC 225		
240	KMLC 240		

- 1) **Colori satinati sovrapprezzo 10% sul prezzo del cristallo. Opalite nero sovrapprezzo del 35% sul prezzo dell'Opalite bianco.**

Matt colours increase of 10% on the crystal price. Opalite nero increase of 35% on the Opalite bianco price.

Colores satinados aumento 10% sobre el precio del cristal. Opalite negro aumento del 35% sobre el precio del Opalite Blanco.

- 2) **Top per composizioni a misura prendere il prezzo della lunghezza superiore (Es. composizione 200 cm prezzo top 210 cm).**

Use tops of a wider length for made-to-measure compositions (Ex. for a composition L. 200 cm consider the top L. 210 cm).

Encimera para composiciones a medida tomar el precio de la longitud superior (Ejemplo: composición 200 cm precio encimera 210 cm).

Alzatine e listelli su misura in CRISTALLO e OPALITE.

Made-to-measure splashbacks and side strips in CRISTALLO and OPALITE.

Copete a medida de CRISTALLO y OPALITE.

Art.	H cm	L cm	Prezzo fisso Fixed price Precio fijo	
			CRISTALLO	OPALITE BIANCO
K06A	4 → 10	→ 100		
		101 → 150		
		151 → 195		
		196 → 240		
K06B	11 → 16	→ 100		
		101 → 150		
		151 → 195		
		196 → 240		



Molatura bordi - Edge grinding - Acabados del borde

TOP MOHO spessore 17 mm.

MOHO TOP 17 mm thick.

TOP MOHO grosor 17 mm.



Indicare posizione lavabo - Indicate position of basin - Indicar posición lavabo

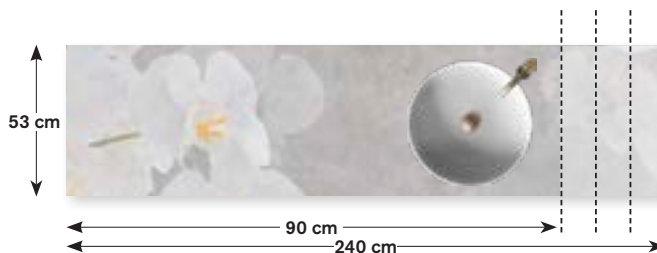

CE Cherry



CL Calypso



GA Garden

Top MOHO per lavabo in appoggio, sottopiano e semincasso - LAVABO SINGOLO.

MOHO top for sit on, under level and semi-recessed basins - SINGLE BASIN.

Top MOHO para lavabo de apoyo, bajo encimera o semiencastré - 1 LAVABO.

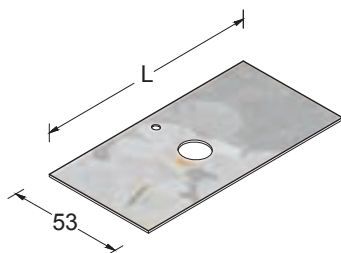

L cm	Art.	MOHO Cherry Calypso Garden
90	KSK 90	
105	KSK105	
120	KSK 120	
135	KSK 135	
150	KSK 150	
165	KSK 165	
180	KSK 180	
195	KSK 195	
210	KSK 210	
225	KSK 225	
240	KSK 240	

- 1) **Foro rubinetteria monoforo centrale di serie. Su richiesta senza foro, 3 fori.**

Single central tap hole as standard. Upon request 3 tap holes or no tap hole.

Agujero grifería centrado de serie. Sobre pedido sin agujero, 3 agujeros.

- 3) **Per l'utilizzo di altri lavabi no Artelinea indicare marca e modello con aumento di €. Richiedere fattibilità.**

For all the basins which are not produced by Artelinea please indicate brand and model and increase the price of the top by €. Ask for feasibility.

Para lavabos de otros fabricantes indicar marca y modelo con aumento de €106,00. Consultar factibilidad.

- 2) **Top per composizioni a misura prendere il prezzo della lunghezza superiore (Es. composizione 200 cm prezzo top 210 cm).**

Use tops of a wider length for made-to-measure compositions (Ex. for a composition L. 200 cm consider the top L. 210 cm).

Encimera para composiciones a medida tomar el precio de la longitud superior (Ejemplo: composición 200 cm precio encimera 210 cm).



Molatura bordi - Edge grinding - Acabados del borde

Decorì vedi pag. 20. - Decorations see page 20. - Decorados ver página 20.

TOP MOHO spessore 17 mm.

MOHO TOP 17 mm thick.

TOP MOHO grosor 17 mm.

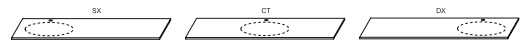

Indicare posizione lavabo - Indicate position of basin - Indicar posición lavabo

Top MOHO per lavabo in appoggio, sottopiano e semincasso - LAVABO DOPPIO.

MOHO top for sit on, under level and semi-recessed basins - DOUBLE BASINS.

Top MOHO para lavabo de apoyo, bajo encimera o semiencastré - 2 LAVABOS.

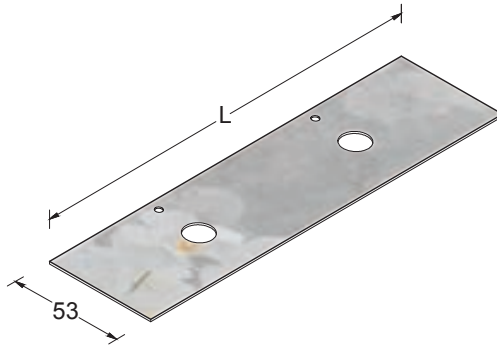

L cm	Art.	MOHO Cherry Calypso Garden
120	KSKD 120	
135	KSKD 135	
150	KSKD 150	
165	KSKD 165	
180	KSKD 180	
195	KSKD 195	
210	KSKD 210	
225	KSKD 225	
240	KSKD 240	

Top MOHO per basi e cassettiere senza lavabo.

MOHO top for base units.

Top MOHO para bases y cajoneras sin lavabo.

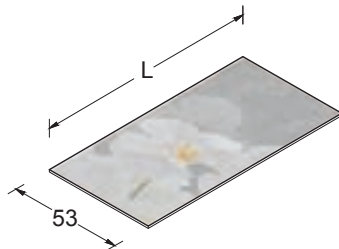

L cm	Art.	MOHO Cherry Calypso Garden
90	KSKC 90	
105	KSKC 105	
120	KSKC 120	
135	KSKC 135	
150	KSKC 150	
165	KSKC 165	
180	KSKC 180	
195	KSKC 195	
210	KSKC 210	
225	KSKC 225	
240	KSKC 240	

- 1) **Foro rubinetteria monoforo centrale di serie.**
Su richiesta senza foro, 3 fori.

*Single central tap hole as standard.
Upon request 3 tap holes or no tap hole.*

Agujero grifería centrado de serie.
Sobre pedido sin agujero, 3 agujeros.

- 3) **Per l'utilizzo di altri lavabi no Artelinea indicare marca e modello con aumento di €. Richiedere fattibilità.**

For all the basins which are not produced by Artelinea please indicate brand and model and increase the price of the top by €. Ask for feasibility.

Para lavabos de otros fabricantes indicar marca y modelo con aumento de €. Consultar factibilidad.

- 2) **Top per composizioni a misura prendere il prezzo della lunghezza superiore (Es. composizione 200 cm prezzo top 210 cm).**

Use tops of a wider length for made-to-measure compositions (Ex. for a composition L. 200 cm consider the top L. 210 cm).

Encimera para composiciones a medida tomar el precio de la longitud superior (Ejemplo: composición 200 cm precio encimera 210 cm).



Molatura bordi - Edge grinding - Acabados del borde



Inclusa - Included - Incluida

+SKIN/GLASS Decor Collection

ALZATINA GLASS spessore 17 mm.
 GLASS SPLASHBACK - 17 mm thick.
 COPETE GLASS grosor 17 mm.

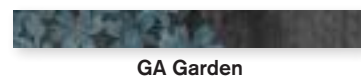
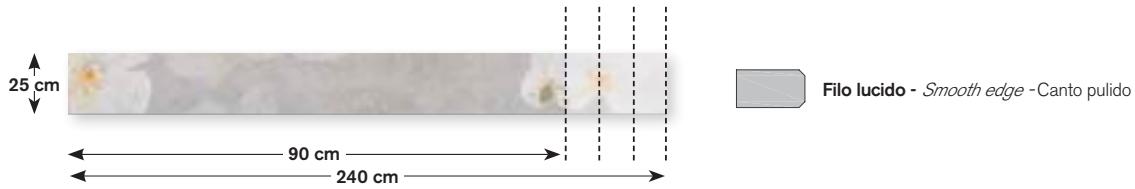

Alzatina abbinata a top Moho.
 Splashback matching the Moho top.
 Copete combinabile a top MOHO.

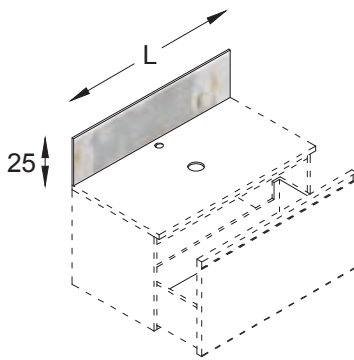

L cm	Art.	GLASS DECOR		
		Cherry	Calypso	Garden
90	KKSK90			
105	KKSK105			
120	KKSK120			
135	KKSK135			
150	KKSK150			
165	KKSK165			
180	KKSK180			
195	KKSK195			
210	KKSK210			
225	KKSK225			
240	KKSK240			

Decorì vedi pag. 20. - Decorations see page 20. - Decorados ver página 20.

LAVABI IN OPALITE - *OPALITE BASINS* - LAVABOS DE OPALITE

Lavabi in OPALITE da appoggio.

OPALITE sit on basins.

Lavabos de OPALITE de apoyo.



Inclusa
Included
Incluida

Lavabo termofuso in Opalite da appoggio ovale completo di anello alla base smaltato esternamente bianco lucido o nero lucido.

Thermofused elliptical sit on basin in Opalite with mounting ring at its base. Extrernal finishes: shiny white or black.

Lavabo termofundido de Opalite de apoyo oval con anillo para la base esmaltado externamente blanco brillo o negro brillo.

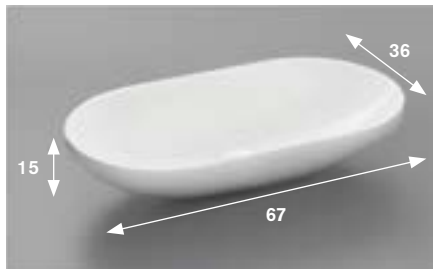

Design Arte L. Studio

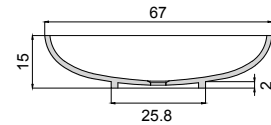

BIANCO LUCIDO	NERO LUCIDO
<i>SHINY WHITE</i>	<i>SHINY BLACK</i>
BLANCO BRILLO	NEGRO BRILLO

Art.

B.90

Lavabo termofuso in Opalite da appoggio tondo completo di anello alla base smaltato esternamente bianco lucido o nero lucido.

Thermofused round sit on basin in Opalite with mounting ring at its base. Extrernal finishes: shiny white or black.

Lavabo termofundido de Opalite de apoyo redondo con anillo para la base esmaltado externamente blanco brillo o negro brillo.



Design Arte L. Studio

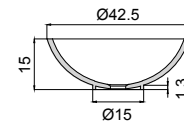

BIANCO LUCIDO	NERO LUCIDO
<i>SHINY WHITE</i>	<i>SHINY BLACK</i>
BLANCO BRILLO	NEGRO BRILLO

Art.

B.91

Lavabo termofuso in Opalite da appoggio smaltato esternamente bianco lucido o nero lucido.

Thermofused sit on basin in Opalite. Extrernal finish: shiny white or black.

Lavabo termofundido en Opalite da apoyo esmaltado externamente blanco brillo o negro brillo.



Design Arte L. Studio

BIANCO LUCIDO	NERO LUCIDO
<i>SHINY WHITE</i>	<i>SHINY BLACK</i>
BLANCO BRILLO	NEGRO BRILLO

Art.

B.18

LAVABI IN OPALITE - *OPALITE BASINS* - LAVABOS DE OPALITE

Lavabi in OPALITE semincasso.

Semi-recessed OPALITE basins.

Lavabos de OPALITE de semiencastré.



Inclusa
Included
Incluida

Lavabo termofuso in Opalite semincasso.

Thermofused semi-recessed basin in Opalite.

Lavabo termofundido de Opalite de semiencastré.

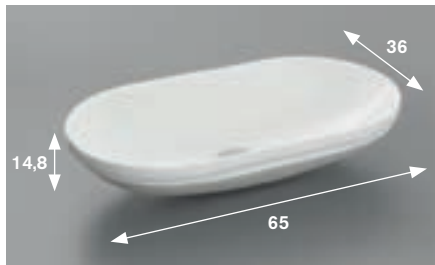

Design Arte L. Studio

Art.

OPALITE BIANCO

OPALITE NERO

B.86

Lavabo termofuso in Opalite semincasso.

Thermofused semi-recessed basin in Opalite.

Lavabo termofundido de Opalite de semiencastré.



Design Arte L. Studio

Art.

OPALITE BIANCO

OPALITE NERO

B.87