

# T-60 COLLECTION



## T-60 Collection



### ORDINA FACILE

EASY ORDER

ORDENA EL PEDIDO

YOU SHOULD INDICATE IN YOUR PO:

- item code
- leg finish
- material of the top
- position and model of the wash-basin
- position and number of tap holes
- code of the unit +Skin collection
- finish of the unit +Skin collection
- splashback (option)

### INDICARE NELL'ORDINE:

- codice articolo
- finitura gamba
- materiale top
- posizione e modello lavabo
- posizione e numero fori rubinetto
- codice mobile +Skin collection
- finitura mobile +Skin collection
- alzatina (optional)

### INDICAR EN EL PEDIDO:

- código artículo
- acabado pata
- material top
- posición y modelo del lavabo
- posición y número de agujeros grifería
- código mueble + Skin Collection
- acabado mueble + Skin Collection
- copete (opcional)

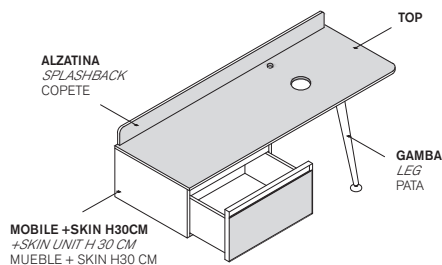

Note:

### 43 Sifone consigliato per collegamento scarico nostro articolo B.22.

*Recommended syphon for connection with drain, our item B.22.*

Sifón aconsejado para instalar nuestro artículo B.22.

## CARATTERISTICHE TECNICHE DEL PRODOTTO

TECHNICAL CHARACTERISTICS

CARACTERÍSTICAS TÉCNICAS DEL PRODUCTO

### STRUTTURA PORTALAVABO - STRUCTURE - ESTRUCTURA PORTALAVABO

Gamba in acciaio verniciato in finitura Peltro o Bronzo e staffa di sostegno in zinco verniciato. Mobile +Skin collection H30cm posizionato dal lato opposto alla gamba in caso di una sola gamba o nel centro nel caso di doppia gamba.

*Leg in stainless steel varnished in Peltro or Bronzo finish and support bracket in varnished zincor. +Skin collection unit H30cm positioned on the opposite side of the leg with 1 leg or at the center of the structure with 2 legs.*

Pata de acero barnizado con acabados Peltro o Bronce y soporte de sujeción de zincor barnizado. Mueble + Skin collection H.30 cm situado al lado opuesto de la pata en el caso de una sola pata o en el centro en el caso de dos patas.



PE peltro

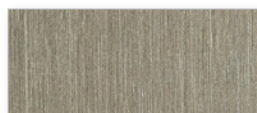

BR bronzo

### TOP CRISTALLO, OPALITE E SPECCHIO - CRISTALLO, OPALITE AND SPECCHIO TOP - TOP CRISTAL, OPALITE Y ESPEJO

Top in CRISTALLO smaltato lucido e silk, in OPALITE bianco o nero e SPECCHIO FUME' GRIGIO, SPECCHIO FUME' BRONZO, SPECCHIO 02. Il top a SPECCHIO è formato dall'accoppiamento di stratifica di cristallo extrachiaro verniciato sp.12mm, collante e specchio sp. 5mm per uno spessore totale di circa 18 mm.

Il top è raggato in corrispondenza della gamba.

*Top in enameled GLASS gloss or silk finish, in OPALITE bianco or nero finish, SPECCHIO FUME' GRIGIO, SPECCHIO FUME' BRONZO, SPECCHIO 02. The tops in MIRROR finish are formed by the stratified matching of 1 layer of extra-clear enameled glass in 12 mm thickness, the sealant and 1 layer of 20mirror in 5 mm thickness for a total thickness of about 18 mm.*

Top de CRISTAL esmaltado brillo o silk, de OPALITE blanco o negro y a ESPEJO FUME' GRIS, ESPEJO FUME' BRONCE, ESPEJO 02.

El top a ESPEJO está formado por el acoplamiento de estratificado de cristal extraclaro barnizado grosor 12 mm, cola y espejo grosor 5 mm con un grosor total de aproximadamente 18 mm.

El top es redondeado en correspondencia con la pata.



L8 specchio fumé grigio



L9 specchio fumé bronzo



02 specchio

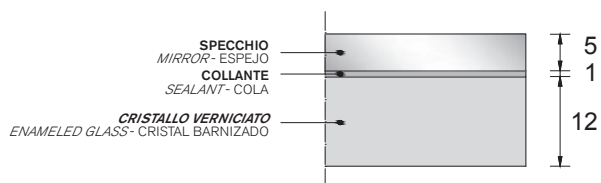

## TOP MOHO

Top formato dall'accoppiamento di stratifica tra 2 cristalli trasparenti extrachiarissimi sp.8 mm e decoro interposto per uno spessore totale di circa 17 mm. Top disponibile con i 3 decori Cherry, Calypso e Garden. Il top è raggiato in corrispondenza della gamba.

Top formed by the stratified matching of 2 layers of extra-clear glass, 8mm each, and 1 central layer of decoration for a total thickness of about 17 mm. Top available with the 3 decorations: Cherry, Calypso and Garden. Rounded corner over the leg.

Top formado por el acoplamiento laminado entre 2 cristales transparentes extraclaros grosor 8 mm y decorado interpuesto con un grosor total de aproximadamente 17 mm. Top disponible con los 3 decorados Cherry, Calypso y Garden. El top es redondeado en correspondencia con la pata.

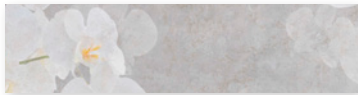
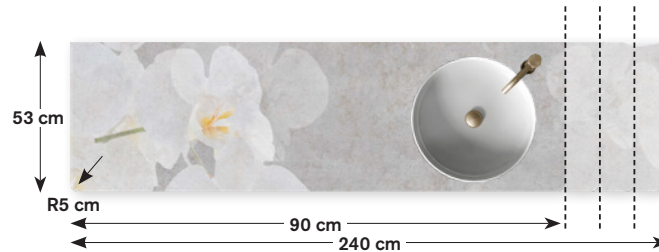

CE Cherry

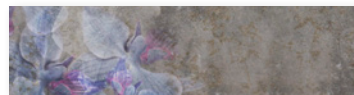

CL Calypso



GA Garden

### SCHEDE TECNICHE PER INSTALLAZIONE

TECHNICAL INSTALLATION ADVICE

ESQUEMA TECNICO PARA INSTALACION

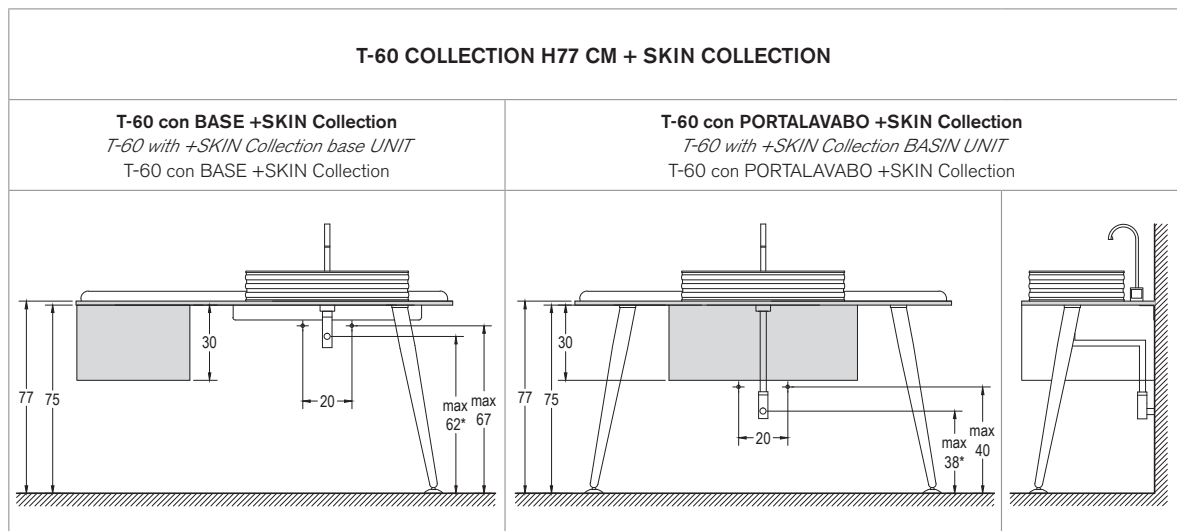

\* QUOTA CALCOLATA CON N.S. SIFONE ART.B22

\* MEASURE CALCULATED WITH OUR SYPHON B22.

\* COTA CALCULADA CON NUESTRO SIFÓN ART. B.22

## T-60 Collection

**CONSOLLE VERSIONE PELTRO CON RIVESTIMENTO MOBILE +SKIN STATUARIO BIANCO**  
*CONSOLE WITH LEGS IN PELTRO FINISH AND +SKIN BASIN UNIT IN STATUARIO BIANCO FINISH*  
CONSOLA VERSIÓN PELTRO CON REVESTIMIENTO MUEBLE +SKIN STATUARIO BLANCO



**CONSOLLE VERSIONE PELTRO CON RIVESTIMENTO MOBILE +SKIN SPECCHIO STAMPATO GRIGIO**  
*CONSOLE WITH LEGS IN PELTRO FINISH AND +SKIN BASIN UNIT IN SPECCHIO STAMPATO GRIGIO FINISH*  
CONSOLA VERSIÓN PELTRO CON REVESTIMIENTO MUEBLE +SKIN ESPEJO ESTAMPADO GRIS



**CONSOLLE VERSIONE BRONZO CON RIVESTIMENTO MOBILE FLUTES BIANCO**  
*CONSOLE WITH LEGS IN BROZO FINISH AND +SKIN BASIN UNIT IN FLUTES BIANCO FINISH*  
CONSOLA VERSIÓN BRONZE CON REVESTIMIENTO MUEBLE FLUTES BLANCO.



# T-60 Collection

PROFONDITA' - DEPTH - PROFUNDIDAD 53 cm - H 77 cm

**Consolle ad 1 gamba con lavabo singolo. Versione sx e dx.**

*Console with 1 leg with single basin. Left and right versions.*

Consola de 1 pata con 1 lavabo. Versión sx o dx.

**Consolle a 2 gambe con lavabo singolo. Versione centrale**

*Console with 2 legs with single basin. Central version.*

Consola de 2 patas con 1 lavabo. Versión centrada.

**Consolle ad 1 gamba con lavabo doppio. Versione sx e dx**

*Console with 1 leg with 2 basins. Left and right versions.*

Consola de 1 pata con 2 lavabos. Versión sx o dx.

**Consolle a 2 gambe con lavabo doppio.**

*Console with 2 legs with double basins.*

Consola de 2 patas con 2 lavabos.

**Consolle portalavabo con 1 gamba in acciaio finitura Peltro o Bronzo. Top in cristallo smaltato lucido o silk, specchio fumé grigio/ fume' bronzo, specchio 02, Opalite bianco o Moho con lavabo singolo o doppio e fori rubinetto.**

*Basin console with 1 leg in stainless steel Peltro or Bronzo finish. Top in enameled glass in gloss or silk finish, mirror in fumé grigio/ fumé bronzo or specchio 02, in opalite bianco or Moho with single basin or double basins and tap holes.*

Consola portalavabo con 1 pata de acero acabado Peltro o Bronce. Top de cristal esmaltado brillo o silk, espejo fumé gris/fumé bronze, espejo 02, Opalite Blanco o Moho para 1 o 2 lavabos y agujeros grifería.

Note: 43 (pag. 34)

**Consolle portalavabo con 1 gamba, lavabo singolo e foro rubinetto.**

*Basin console with 1 leg, single basin and tap hole.*

Consola portalavabo con 1 pata para 1 lavabo y agujero grifería.

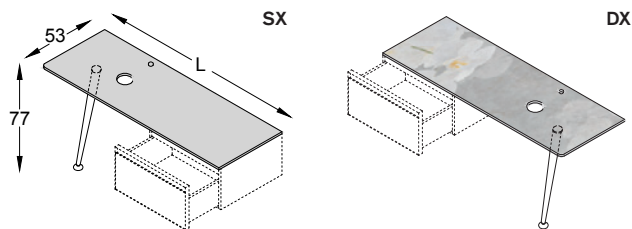

**GAMBA: PELTRO/BRONZO**  
LEG: PELTRO/BRONZO - PATA: PELTRO/BRONCE

L cm.	Art. SX	Art. DX	TOP	TOP MOHO
da/from	a/to		Cristallo	Cherry
120 → 149	KT6A1S	KT6A1D	Opalite Bianco	Calypso
150 → 179	KT6B1S	KT6B1D		Garden
180 → 209	KT6C1S	KT6C1D		TOP SPECCHIO
210 → 240	KT6D1S	KT6D1D		

Note: 43 (pag. 34)

**Consolle portalavabo con 1 gamba, lavabo doppio e fori rubinetto.**

*Basin console with 1 leg, double basins and tap holes.*

Consola portalavabo con 1 pata para 2 lavabos y agujeros grifería.

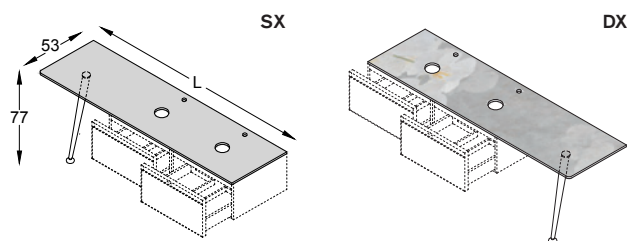

**GAMBA: PELTRO/BRONZO**  
LEG: PELTRO/BRONZO - PATA: PELTRO/BRONCE

L cm.	Art. SX	Art. DX	TOP	TOP MOHO
da/from	a/to		Opalite Bianco	Cherry
210 → 240	KT6DD1S	KT6DD1D		Calypso
				Garden
				TOP SPECCHIO

**1) Foro rubinetteria monoforo centrale di serie. Su richiesta senza foro, 3 fori.**

*Single central tap hole as standard. Upon request 3 tap holes or no tap hole.*

Agujero grifería centrado de serie. Sobre pedido sin agujero, 3 agujeros.

**2) Opalite nero sovrapprezzo del 16% sul prezzo dell'Opalite bianco.**

*Opalite nero increase of 16% on the Opalite bianco price.*

Opalite negro aumento del 16% sobre el precio del Opalite Blanco.

Per mobili da abbinare consultare +Skin Collection. - Base and basin units to be combined with, please see + Skin Collection. - Muebles para combinar consultar +Skin Collection.

Decorati vedi pag. 35. - Decorations see page 35. - Decorados ver página 35.

**Consolle portalavabo con 2 gambe in acciaio finitura Peltro o Bronzo. Top in cristallo smaltato lucido o silk, specchio fumé grigio/ fumé bronzo, specchio 02, Opalite bianco o Moho con lavabo singolo o doppio e fori rubinetto.**

*Basin console with 2 legs in stainless steel Peltro or Bronzo finish. Top in enameled glass in shiny or silk finish, mirror in fumé grigio/ fumé bronzo or specchio 02, in opalite bianco or Moho with single basin or double basin and tap holes.*

Consola portalavabo con 2 patas de acero acabado Peltro o Bronce. Top de cristal esmaltado brillo o silk, espejo fumé gris/fumé bronce, espejo 02, Opalite Blanco o Moho para 1 o 2 lavabos y agujeros grifería.

Note: 43 (pag. 34)

**Consolle portalavabo con 2 gambe, lavabo singolo e foro rubinetto.**

*Basin console with 2 legs, single basin and tap hole.*

Consola portalavabo con 2 patas para 1 lavabo y agujero grifería.

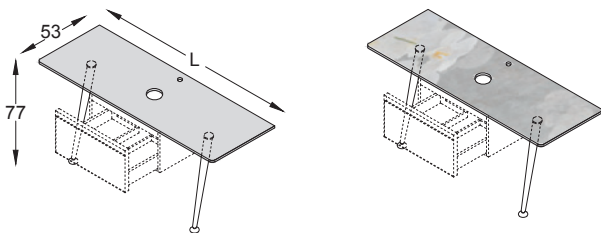

**GAMBA: PELTRO/BRONZO**  
LEG: PELTRO/BRONZO - PATA: PELTRO/BRONCE

TOP	TOP MOHO
Cristallo	Cherry
Opalite Bianco	Calypso
	Garden
	TOP SPECCHIO

L cm.	Art.
da/from a/to	
120 → 149	KT6A2
150 → 179	KT6B2
180 → 209	KT6C2
210 → 240	KT6D2

Note: 43 (pag. 34)

**Consolle portalavabo con 2 gambe, lavabo doppio e fori rubinetto.**

*Basin console with 2 legs, double basins and tap holes.*

Consola portalavabo con 2 patas para 2 lavabos y agujeros grifería.

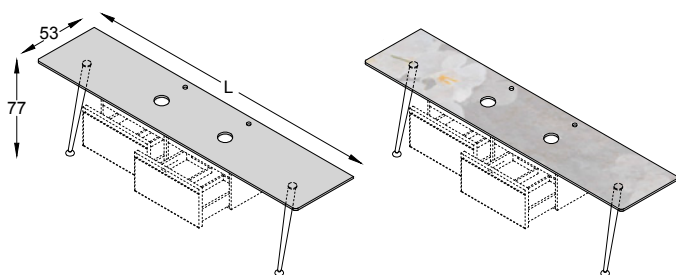

**GAMBA: PELTRO/BRONZO**  
LEG: PELTRO/BRONZO - PATA: PELTRO/BRONCE

TOP	TOP MOHO
Cristallo	Cherry
Opalite Bianco	Calypso
	Garden
	TOP SPECCHIO

L cm.	Art.
da/from a/to	
225 → 240	KT6E2

1) **Foro rubinetteria monoforo centrale di serie. Su richiesta senza foro, 3 fori.**

*Single central tap hole as standard. Upon request 3 tap holes or no tap hole.*

Agujero grifería centrado de serie. Sobre pedido sin agujero, 3 agujeros.

2) **Opalite nero sovrapprezzo del 16% sul prezzo dell'Opalite bianco.**

*Opalite nero increase of 16% on the Opalite bianco price.*

Opalite negro aumento del 16% sobre el precio del Opalite Blanco.

Per mobili da abbinare consultare +Skin Collection. - Base and basin units to be combined with, please see + Skin Collection. - Muebles para combinar consultar +Skin Collection.

Decorì vedi pag. 35. - Decorations see page 35. - Decorados ver página 35.

## T-60 Collection

Note: **52** (pag. 34)

**Alzatina H 4 cm soprapiano in cristallo lucido o silk, specchio fumé grigio/ fume' bronzo, specchio 02 e Opalite bianco. Si consiglia una lunghezza dell'alzatina di 4 cm inferiore alla lunghezza del top.**

*Splashback H.4 cm in gloss or silk glass, mirror fumé grigio/fumé bronzo, specchio 02 and Opalite bianco finishes. The use of a splashback 4mm shorter than the top is recommended.*

Copete H. 4 cm sobreencimera de cristal brillo o silk, espejo fumé gris / fumé bronce, espejo 02 y Opalite Blanco. Se aconseja una longitud de copete de 4 cm inferior a la longitud del top.

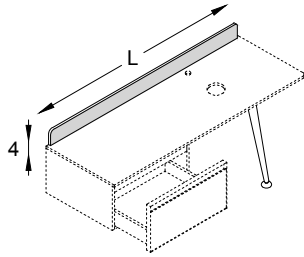

L cm		Art.	Cristallo Opalite Bianco SPECCHIO
da/from	a/to		
116	→ 145	KKT6A	
146	→ 175	KKT6B	
176	→ 205	KKT6C	
206	→ 236	KKT6D	

**Colori satinati sovrapprezzo 10% sul prezzo del cristallo. Opalite nero sovrapprezzo del 35% sul prezzo dell'Opalite bianco.**

*Matt colours increase of 10% on the crystal price. Opalite nero increase of 35% on the Opalite bianco price.*

Colores satinados aumento 10% sobre el precio del cristal. Opalite negro aumento del 35% sobre el precio del Opalite Blanco.



Colori vedi pag. 4. - Colours see page 4 - Colores ver página 4.



## LAVABI IN CERAMICA - CERAMIC BASINS- LAVABOS DE CERAMICA

### Lavabi in ceramica da appoggio.

*Over level white ceramic basins.*

Lavabos de cerámica de apoyo.



**Inclusa**  
*Included*  
Incluida

### Lavabo in ceramica.

*Basin in ceramic.*

Lavabo de cerámica.



<b>Art.</b>	<b>BIANCO</b> <b>Lucido -</b> <i>Shiny - Brillo</i>	<b>NERO</b> <b>Opaco -</b> <i>Matt - Mate</i>
<b>B.73</b>		

### Lavabo in ceramica.

*Basin in ceramic.*

Lavabo de cerámica.



<b>Art.</b>	<b>BIANCO</b> <b>Lucido -</b> <i>Shiny - Brillo</i>	<b>NERO</b> <b>Opaco -</b> <i>Matt - Mate</i>
<b>B.75</b>		

### Lavabo in ceramica.

*Basin in ceramic.*

Lavabo de cerámica.

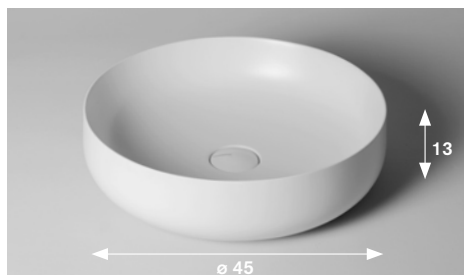

### Solo con foro rubinetto laterale.

*Only with left or right tap hole.*

Solo con agujero grifo lateral.

<b>Art.</b>	<b>BIANCO</b> <b>Lucido -</b> <i>Shiny - Brillo</i>	<b>NERO</b> <b>Opaco -</b> <i>Matt - Mate</i>
<b>B.76</b>		

### Lavabo in ceramica.

*Basin in ceramic.*

Lavabo de cerámica.

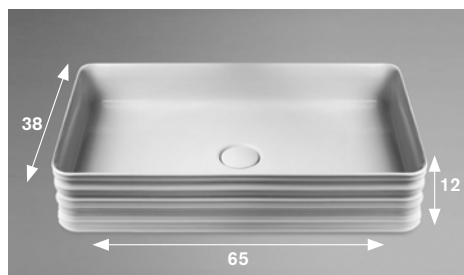

<b>Art.</b>	<b>BIANCO</b> <b>Lucido -</b> <i>Shiny - Brillo</i>	<b>NERO</b> <b>Opaco -</b> <i>Matt - Mate</i>
<b>B.78</b>		

## COMPLEMENTI - ACCESSORIES - COMPLEMENTOS

### Pilette e sifoni.

*Wastes and syphons.*

Válvulas y sifones.

### Scarico in ottone cromato salvaspazio.

*Space saving chrome brass syphon.*

Sifón de latón cromado salvaspacio.

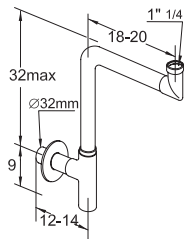

Art.

B.27

### Sifone in ottone cromato completo di piletta click-clack.

*Chrome brass syphon with pop up waste.*

Sifón de latón cromado con válvula click-clack.

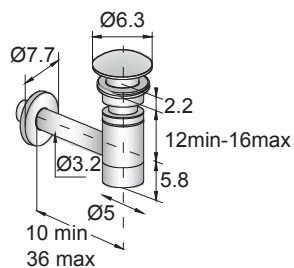

Art.

B.28

### Sifone in ottone cromato completo di piletta click-clack.

*Chrome brass syphon with pop up waste.*

Sifón de latón cromado con válvula click-clack.

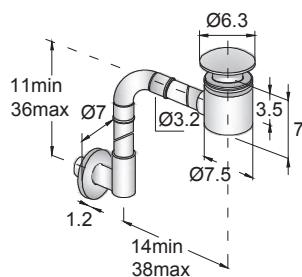

Art.

B.22

### Sifone in ottone con piletta a scarico libero.

*Chrome brass syphon with waste with open drain.*

Sifón de latón cromado con válvula de descarga libre.

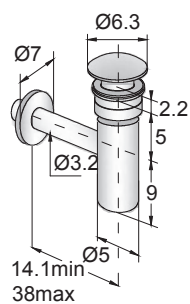

Art.

B.26